

# EQN0408-10 Negative Slope Equalizer

4.0 to 8.0 GHz



## Technical Characteristics

Product Features
Fixed or adjustable attenuation tuning
Low insertion loss
SMA connector standard
Impedance 50 or 75 ohms
Compact size
Meets MIL-E-5400 and MIL-E-16400 environmental requirements

Maximum Ratings	
Max. Input Power	250mW
Operating Temperature	-55 to +95°C
Storage Temperature	-65 to +125°C
Specifications @	25°C

Maximum Ratings	
ECCN: EAR 99 (Unless otherwise specified)	
HTS: 8543.7080.00	

Parameters	Freq. (GHz)	Minimum	Typical	Maximum	Units	Conditions
Attenuation	4.0 to 8.0		10.0		dB	
Insertion Loss	8.0		1.0		dB	
VSWR	4.0 to 8.0		1.5:1			
Linearity	4.0 to 8.0		+/-1.0		dB	
Max. Input Power	4.0 to 8.0			250	mW	

## Package Outline

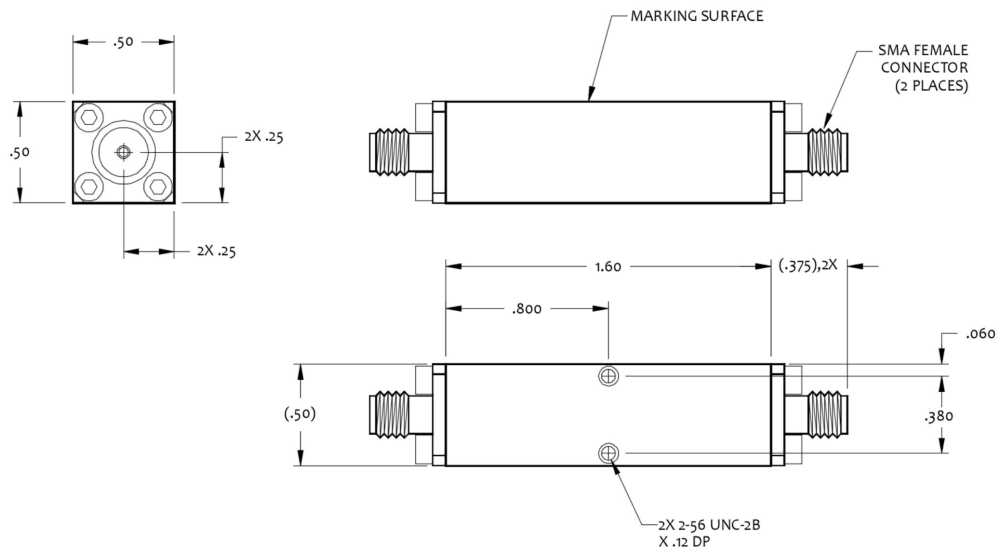

DISCLAIMER: Subject to change without notice.  
Rev(B) 09/12/19

# EQN0408-10 Negative Slope Equalizer

4.0 to 8.0 GHz



## Test Data

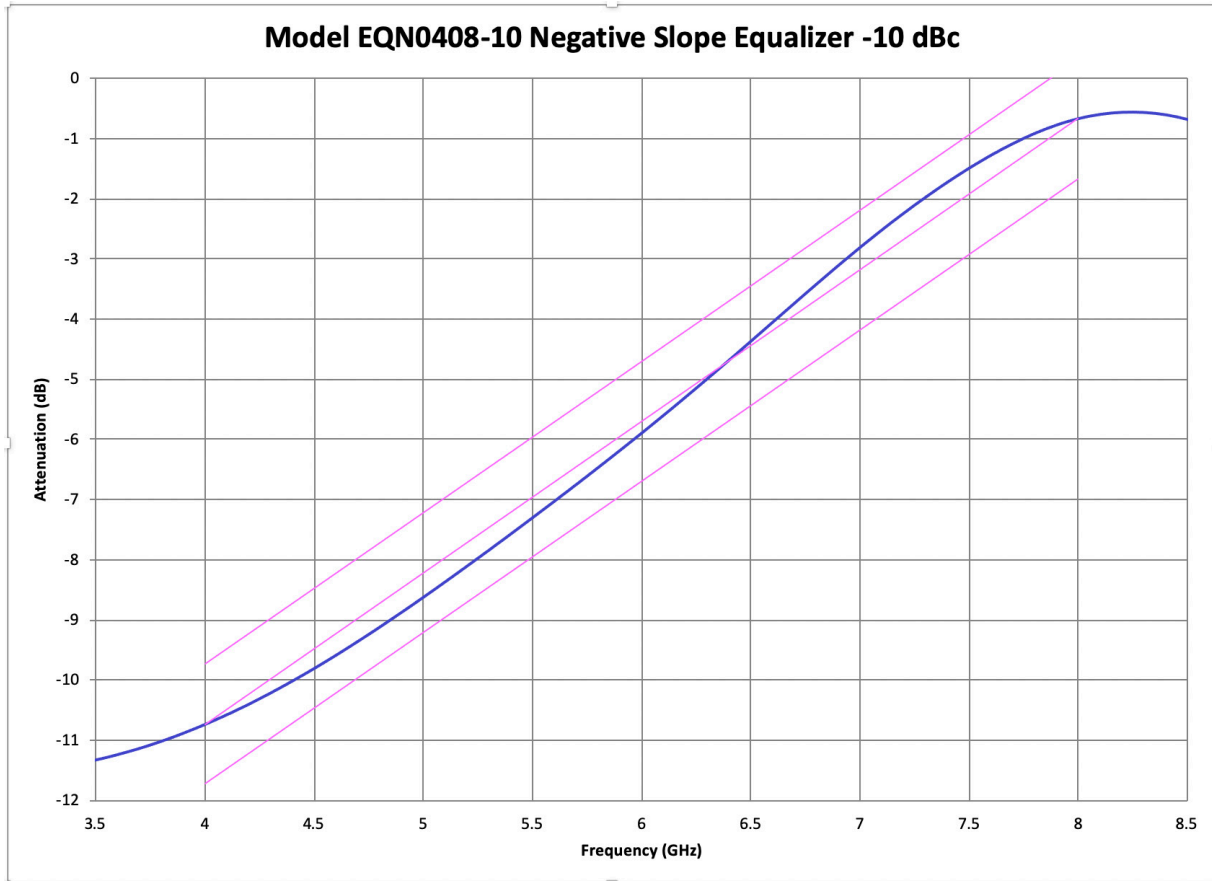

DISCLAIMER: Subject to change without notice.  
Rev(B) 09/12/19